

UNCONTROLLED DOCUMENT

PART NUMBER  
SML-LXL1210SRSYCTR

REV.  
E

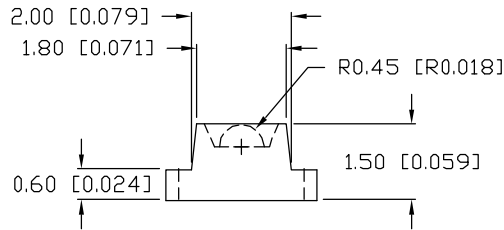
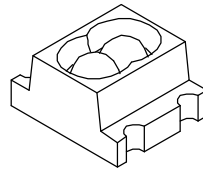
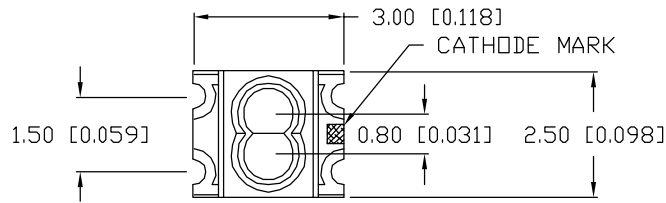

TOP VIEW POLARITY

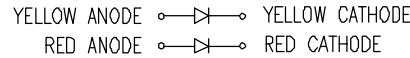

REFLOW PROFILE

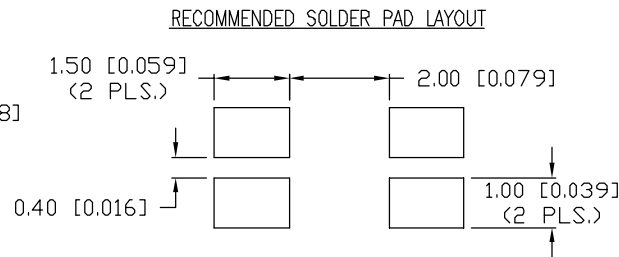
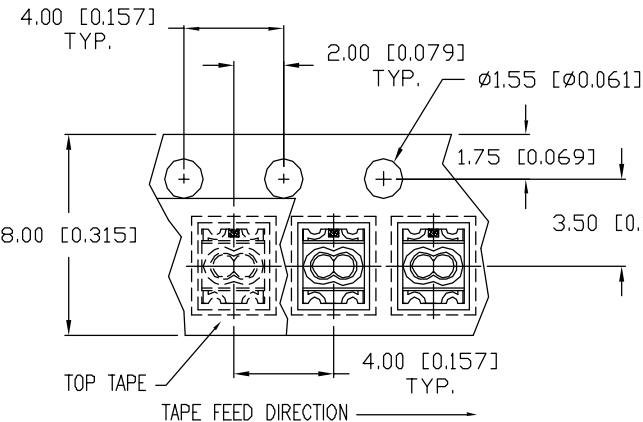
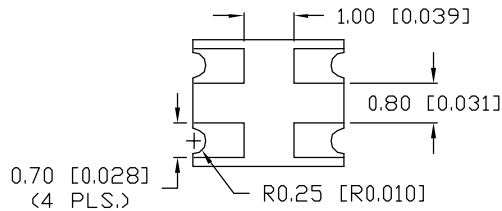
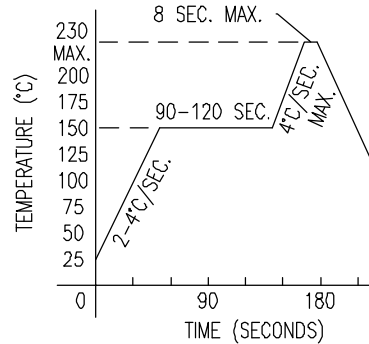

ELECTRO-OPTICAL CHARACTERISTICS  $T_A=25^\circ\text{C}$   $I_f=20\text{mA}$

PARAMETER	MIN	TYP	MAX	UNITS	TEST COND
PEAK WAVELENGTH		660 (RED)		nm	
		590 (YELLOW)		nm	
FORWARD VOLTAGE (R/Y)		1.7/2.1	2.2/2.5	V <sub>f</sub>	
REVERSE VOLTAGE	5.0			V <sub>r</sub>	I <sub>r</sub> =100μA
AXIAL INTENSITY (R/Y)		50/90		mcd	I <sub>f</sub> =20mA
VIEWING ANGLE		60		2x theta	
EMITTED COLOR:	RED/YELLOW				
EPOXY LENS FINISH:	WATER CLEAR				

LIMITS OF SAFE OPERATION AT 25°C

PARAMETER	COLORS	MAX	UNITS
PEAK FORWARD CURRENT*		160	mA
STEADY CURRENT		25	mA
POWER DISSIPATION	(R/Y)	60/100	mW
DERATE FROM 25°C		-1.0	mW/°C
OPERATING TEMP.		-40 TO +85	°C
STORAGE TEMP.		-40 TO +90	°C

\*  $t < 10\mu\text{s}$

NOTES:

1. THE POLARITY MARK IS ORIENTED TOWARDS THE TAPE SPROCKET HOLE.

CAUTION: MOISTURE SENSITIVE DEVICE  
PER JEDEC LEVEL 4 STANDARDS

UNCONTROLLED DOCUMENT

\*UNLESS OTHERWISE SPECIFIED TOLERANCES PER DECIMAL PRECISION ARE: X=±1 (±0.039), X.X=±0.5 (±0.020), X.XX=±0.25 (±0.010), X.XXX=±0.127 (±0.005). LEAD SIZE=±0.05 (±0.002), LEAD LENGTH=±0.75 (±0.030). MIN.=+DECIMAL PRECISION MAX.=+0.00 -DECIMAL PRECISION

REV. E PART NUMBER SML-LXL1210SRSYCTR

CONFIDENTIAL INFORMATION  
THE INFORMATION CONTAINED IN THIS DOCUMENT IS THE PROPERTY OF LUMEX INC. EXCEPT AS SPECIFICALLY AUTHORIZED IN WRITING BY LUMEX INC., THE HOLDER OF THIS DOCUMENT SHALL KEEP ALL INFORMATION CONTAINED HEREIN CONFIDENTIAL AND SHALL PROTECT SAME IN WHOLE OR IN PART FROM DISCLOSURE AND DISSEMINATION TO ALL THIRD PARTIES.



290 E. HELEN ROAD  
PALATINE, IL 60067-6976  
PHONE: +1.847.359.2790  
US WEB: www.lumex.com  
TW WEB: www.lumex.com.tw

2.7mm x 3.0mm PCB, SURFACE MOUNT LED,  
SUPER RED/SUPER YELLOW CHIPS,  
WATER CLEAR LENS, TAPE AND REEL.

RELIABILITY NOTE  
OUR MANY YEARS OF EXPERIENCE DATA ACCUMULATION INDICATE THAT SOLDER HEAT IS A MAJOR CAUSE OF EARLY AND FUTURE FAILURE. PLEASE PAY ATTENTION TO YOUR SOLDERING PROCESS.

DRAWN BY: CT CHECKED BY: APPROVED BY: DATE: 10.14.97  
PAGE: 1 OF 1  
SCALE: N/A